



VINIT MACHINES PVT. LTD.

How to Select the Lathe Machine

First of all you should match specifications of both, one the machine which you are going to purchase and second of your job, you want to do on the machine.

Centre Height : Centre height of your machine must be match with O.D. of your job. Swing over bed and swing over cross slide should be select as per your job.

Spindle bore : Spindle bore should be with such dimensions that your job O.D. may be pass through it easily if it is necessary.

Width of bed : More Width of bed gives more rigidity and sturdiness to the machine. It is necessary in heavy work.

Drive : In belt driven, there are two options, flat belt and V-belt driven. Flat belt is slipped when there are over capacity work taken on the machine and V-belt is sturdy design to remove some what slipping actions. And in Gears drive (Geared Head Lathe Machine), It gives more power to turn as well as it is suit for more speed and feed and resultant it increases productivity and low electricity consumption.

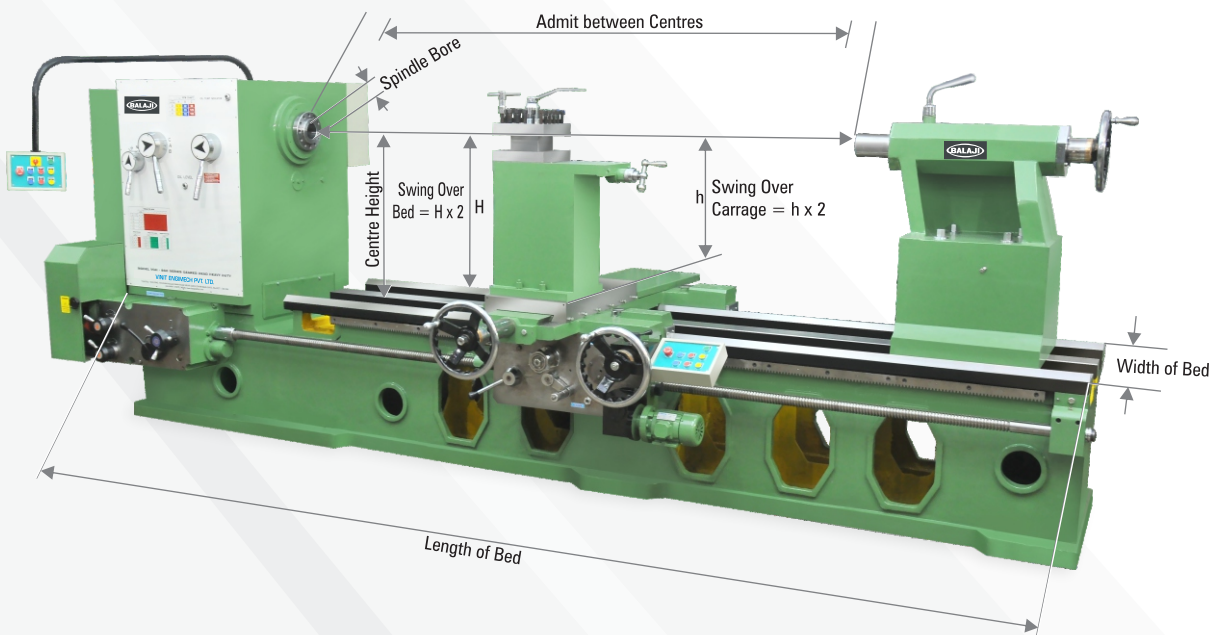



VINIT MACHINES PVT. LTD.

about us

Precision, Quality and Time Bound Delivery. The three prime key point which led to the start-up of **VINIT MACHINES PVT.LTD.** in the year 1979.

Since then company is redefining all three prime key points with its lathe machine products with the brand names of "Balaji Lathe". The gradual and steady progress towards its vision to satisfy the primary requirements i.e. Precision, quality and time bound delivery, in its products, **VINIT MACHINES PVT.LTD.** now enjoys the vital share in lathe machineries industry in India as well as abroad.

Company's founder Mr. J.S. Padalia holds masters degree in engineering and have significant experience in lathe machine production. Under his expert direction as well as with skilled workforce company is capable to provide custom lathe machines as per client's requirements in cost-affective, quality centric and time bound frame.

While identifying and adopting the new trends in mechanics company keep refining its definition and practice of precision, quality and time bound delivery.



LATHE

ISO 9001:2015
CERTIFIED COMPANY

**CONE PULLEY LIGHT DUTY
LATHE MACHINE
MODEL - VL**





MODEL - VL CONE PULLEY LIGHT DUTY LATHE MACHINE : TECHNICAL SPECIFICATIONS

BED	
LENGTH OF BED	1370 mm (4'-6")
ADMIT BETWEEN CENTRE	660 mm
TYPE OF BED	Hardened Bed Ways
SWING OVER BED	325 mm
HEIGHT OF CENTRE	165 mm
WIDTH OF BED	240 mm
SWING OVER CROSS SLIDE	175 mm
SWING IN GAP	500 mm
LENGTH OF GAP IN FRONT OF FACE PLATE	115 mm

MAIN SPINDLE	
NO. OF SPINDLE SPEED	8
SPINDLE SPEED RANGE	35 to 750 RPM
TAPER IN SPINDLE	MT-5
SPINDLE BORE	38 mm
SPINDLE NOSE	Threaded
SPINDLE THREADS	8 TPI

THREADS	
LEAD SCREW DIAMETER / PITCH	25.4 mm / 4 TPI
NOS. OF THREADS/RANGE (WITHOUT NORTON GEAR BOX)	METRIC : 13 / 1 mm TO 6 mm PITCH INCH : 19 / 2 to 24 TPI
NOS. OF THREADS/RANGE (FOR FULL NORTON GEAR BOX)	METRIC : 24 / 0.5 mm TO 15 mm PITCH INCH : 44 / 2 to 60 TPI
NO. OF FEEDS	19
RANGE OF LONGITUDINAL FEEDS	0.165 - 2 mm
RANGE OF TRANSVERSE FEEDS	0.04 - 0.485 mm

TAIL STOCK	
TAIL STOCK SPINDLE DIAMETER	38.1 mm
TAPER IN TAIL STOCK QUILL	MT - 3

TRAVEL AND TOOLS	
CROSS SLIDE TRAVEL	175 mm
COMPOUND SLIDE TRAVEL	125 mm
TAIL STOCK SLEEVE TRAVEL	120 mm
TOOL POST SQUARE	88 mm
TOOL SHANK SIZE	20 mm
SUITABLE ELECTRICAL HP	1 HP (3 phase)

STANDARD ACCESSORIES :	
■	CHUCK BACK PLATE
■	CENTRE ADAPTER
■	DEAD CENTRES 2 NOS
■	TOOL POST SPANNER
■	MOTOR PULLEY
■	THREAD DIAL INDICATOR
■	CHANGE GEAR SET
■	CHIP TRAY

OPTIONAL ACCESSORIES :	
■	INDEPENDENT CHUCK
■	SELF CENTRING CHUCK
■	CHUCK BACK PLATE EXTRA
■	STEADY REST
■	FOLLOW REST
■	FACE PLATE
■	CARRIER PLATE
■	TAPER TURNING ATTACHMENT
■	COOLANT PUMP WITH TANK AND FITTINGS
■	REAR TOOL POST
■	ELECTRICALS (MOTOR, WIRING, SWITCH, V-BELTS AND FITTINGS)
■	NORTON GEAR BOX
■	SPLASH GUARD
■	FOUNDATION ROUND PLATE WITH LEVELLING BOLTS
■	QUICK CHANGE TOOL POST
■	KEY WAY ATTACHMENT

NOTE : As improvements are constantly made in our machines, the above illustrations, specifications, dimensions and technical data are subject to modifications and change without prior notice and not binding on us.



LATHE
ISO 9001:2015
CERTIFIED COMPANY

CONE PULLEY MEDIUM DUTY
LATHE MACHINE
MODEL - VM - 4S

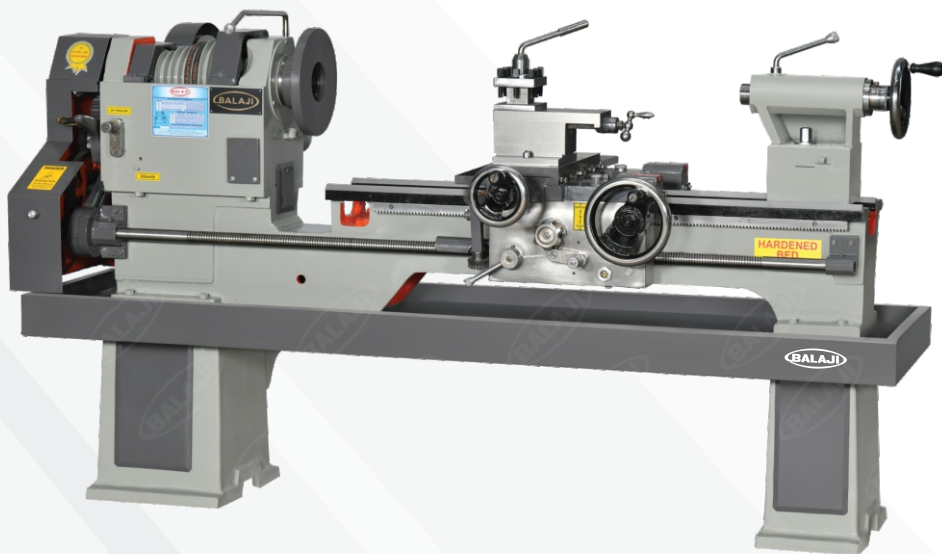



MODEL - VM - 4S CONE PULLEY MEDIUM DUTY LATHE MACHINE : TECHNICAL SPECIFICATIONS

BED	
LENGTH OF BED	1900 mm (6'-3")
ADMIT BETWEEN CENTRE	1000 mm
TYPE OF BED	Hardened Bed Ways
SWING OVER BED	420 mm
HEIGHT OF CENTRE	215 mm
WIDTH OF BED	277 mm
SWING OVER CROSS SLIDE	240 mm
SWING IN GAP	620 mm
LENGTH OF GAP IN FRONT OF FACE PLATE	125 mm

MAIN SPINDLE	
NO. OF SPINDLE SPEED	8
SPINDLE SPEED RANGE	50 to 475 RPM
TAPER IN SPINDLE	MT-6
SPINDLE BORE	50 mm
SPINDLE NOSE	Threaded
SPINDLE THREADS	6 TPI

THREADS	
LEAD SCREW DIAMETER / PITCH	31.75 mm / 4 TPI
NOS. OF THREADS/RANGE (WITHOUT NORTON GEAR BOX)	METRIC : 13 / 1 mm to 6 mm PITCH INCH : 19 / 2 to 24 TPI
NOS. OF THREADS/RANGE (FOR FULL NORTON GEAR BOX)	METRIC : 24 / 0.5 mm to 15 mm PITCH INCH : 44 / 2 to 60 TPI
NO. OF FEEDS	19
RANGE OF LONGITUDINAL FEEDS	0.165 - 2 mm
RANGE OF TRANSVERSE FEEDS	0.04 - 0.485 mm

TAIL STOCK	
TAIL STOCK SPINDLE DIAMETER	50.8 mm
TAPER IN TAIL STOCK QUILL	MT - 4

TRAVEL AND TOOLS	
CROSS SLIDE TRAVEL	230 mm
COMPOUND SLIDE TRAVEL	140 mm
TAIL STOCK SLEEVE TRAVEL	140 mm
TOOL POST SQUARE	100 mm
TOOL SHANK SIZE	20 mm
SUITABLE ELECTRICAL HP	2 HP (3 phase)

STANDARD ACCESSORIES :

- CHUCK BACK PLATE
- CENTREADAPTER
- DEAD CENTRES 2 NOS
- TOOL POST SPANNER
- MOTOR PULLEY
- THREAD DIAL INDICATOR
- CHANGE GEAR SET
- CHIP TRAY

OPTIONAL ACCESSORIES :

- INDEPENDENT CHUCK
- SELF CENTRING CHUCK
- CHUCK BACK PLATE EXTRA
- STEADY REST
- FOLLOW REST
- FACE PLATE
- CARRIER PLATE
- TAPER TURNING ATTACHMENT
- COOLANT PUMP WITH TANK AND FITTINGS
- REAR TOOL POST
- ELECTRICALS (MOTOR, WIRING, SWITCH, V-BELTS AND FITTINGS)
- NORTON GEAR BOX (SINGLE OR DOUBLE SHAFT)
- SPLASH GUARD
- FOUNDATION ROUND PLATE WITH LEVELLING BOLTS
- QUICK CHANGE TOOL POST
- KEY WAY ATTACHMENT

NOTE : As improvements are constantly made in our machines, the above illustrations, specifications, dimensions and technical data are subject to modifications and change without prior notice and not binding on us.



LATHE
ISO 9001:2015
CERTIFIED COMPANY

**CONE PULLEY MEDIUM DUTY
LATHE MACHINE
MODEL - VM 4S-255**

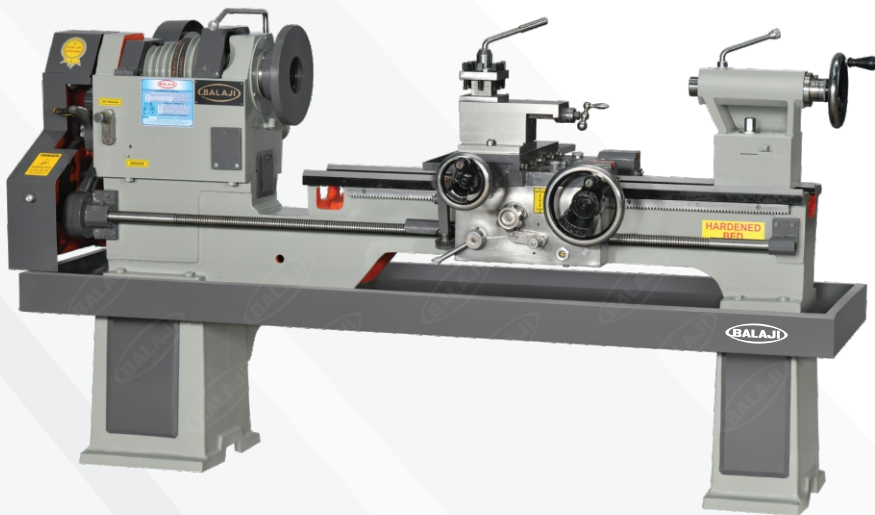



MODEL - VM 4S-255 CONE PULLEY MEDIUM DUTY LATHE MACHINE : TECHNICAL SPECIFICATIONS

BED	
LENGTH OF BED	1900 mm (6'-3")
ADMIT BETWEEN CENTRE	1020 mm
TYPE OF BED	Hardened Bed Ways
SWING OVER BED	495 mm
HEIGHT OF CENTRE	255 mm
WIDTH OF BED	277 mm
SWING OVER CROSS SLIDE	310 mm
SWING IN GAP	700 mm
LENGTH OF GAP IN FRONT OF FACE PLATE	150 mm

MAIN SPINDLE	
NO. OF SPINDLE SPEED	8
SPINDLE SPEED RANGE	50 to 475 RPM*
TAPER IN SPINDLE	MT-6
SPINDLE BORE	80 mm
SPINDLE NOSE	Threaded
SPINDLE THREADS	6 TPI

THREADS	
LEAD SCREW DIAMETER / PITCH	31.75 mm / 4 TPI
NOS. OF THREADS/RANGE (WITHOUT NORTON GEAR BOX)	METRIC : 13 / 1 mm to 6 mm PITCH INCH : 19 / 2 to 24 TPI
NOS. OF THREADS/RANGE (FOR FULL NORTON GEAR BOX)	METRIC : 24 / 0.5 mm to 15 mm PITCH INCH : 44 / 2 to 60 TPI
NO. OF FEEDS	19
RANGE OF LONGITUDINAL FEEDS	0.165 - 2 mm
RANGE OF TRANSVERSE FEEDS	0.04 - 0.485 mm

TAIL STOCK	
TAIL STOCK SPINDLE DIAMETER	50.8 mm
TAPER IN TAIL STOCK QUILL	MT - 4

TRAVEL AND TOOLS	
CROSS SLIDE TRAVEL	270 mm
COMPOUND SLIDE TRAVEL	150 mm
TAIL STOCK SLEEVE TRAVEL	140 mm
TOOL POST SQUARE	120 mm
TOOL SHANK SIZE	25 mm
SUITABLE ELECTRICAL HP	2 HP / 3HP (3 phase)

STANDARD ACCESSORIES :

- CHUCK BACK PLATE
- CENTRE ADAPTER
- DEAD CENTRES 2 NOS
- TOOL POST SPANNER
- MOTOR PULLEY
- THREAD DIAL INDICATOR
- CHANGE GEAR SET
- CHIP TRAY

OPTIONAL ACCESSORIES :

- INDEPENDENT CHUCK
- SELF CENTRING CHUCK
- CHUCK BACK PLATE EXTRA
- STEADY REST
- FOLLOW REST
- FACE PLATE
- CARRIER PLATE
- TAPER TURNING ATTACHMENT
- COOLANT PUMP WITH TANK AND FITTINGS
- REAR TOOL POST
- ELECTRICALS (MOTOR, WIRING, SWITCH, V-BELTS AND FITTINGS)
- NORTON GEAR BOX (SINGLE OR DOUBLE SHAFT)
- SPLASH GUARD
- FOUNDATION ROUND PLATE WITH LEVELLING BOLTS
- QUICK CHANGE TOOL POST
- KEY WAY ATTACHMENT

NOTE : As improvements are constantly made in our machines, the above illustrations, specifications, dimensions and technical data are subject to modifications and change without prior notice and not binding on us.



LATHE
ISO 9001:2015
CERTIFIED COMPANY

**CONE PULLEY HEAVY DUTY
LATHE MACHINE
MODEL - VH-13**

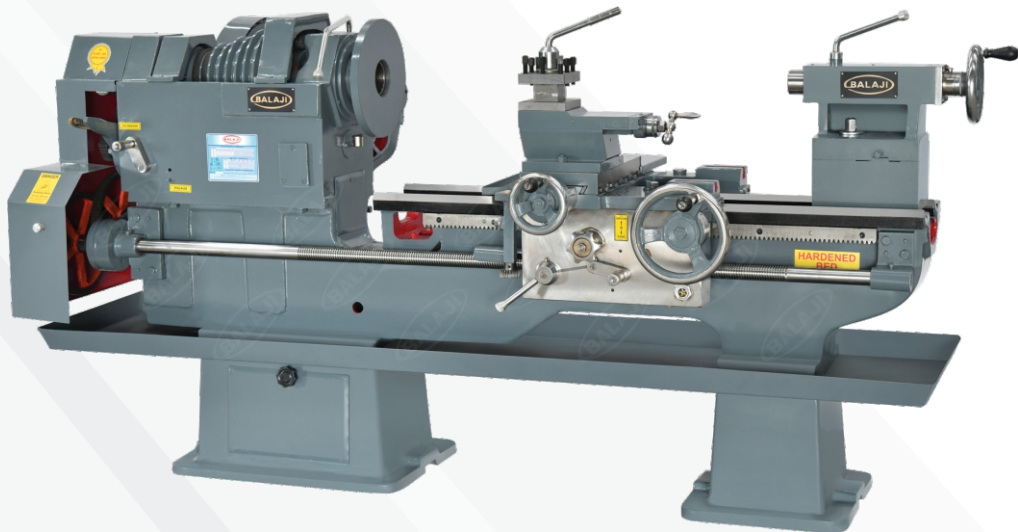



MODEL - VH-13 CONE PULLEY HEAVY DUTY LATHE MACHINE : TECHNICAL SPECIFICATIONS

BED						
LENGTH OF BED	7' (2100 mm)	9' (2740 mm)	10' (3040 mm)	12' (3650 mm)	14' (4260 mm)	16' (4850 mm)
ADMIT BETWEEN CENTRE	1000 mm	1600 mm	1900 mm	2500 mm	3100 mm	3700 mm

TYPE OF BED	Hardened Bed Ways
HEIGHT OF CENTRE	304 mm (12")
SWING OVER BED	600 mm
SWING OVER CROSS SLIDE	395 mm
SWING IN GAP	875 mm
WIDTH OF BED	325 mm
LENGTH OF GAP IN FRONT OF FACE PLATE	200 mm

MAIN SPINDLE	
NO. OF SPINDLE SPEED	8
SPINDLE SPEED RANGE	40 to 340 RPM*
TAPER IN SPINDLE	MT-6
SPINDLE BORE	79 mm / 104 mm / 129 mm
SPINDLE NOSE	Threaded
SPINDLE THREADS	6 TPI

THREADS	
LEAD SCREW DIAMETER / PITCH	38 mm / 4 TPI
NOS. OF THREADS/RANGE (WITHOUT NORTON GEAR BOX)	METRIC : 13 / 1 mm to 6 mm PITCH INCH : 19 / 2 to 24 TPI
NOS. OF THREADS/RANGE (FOR FULL NORTON GEAR BOX)	METRIC : 24 / 0.5 mm to 15 mm PITCH INCH : 44 / 2 to 60 TPI
NO. OF FEEDS	19
RANGE OF LONGITUDINAL FEEDS	0.165 - 1.996 mm
RANGE OF TRANSVERSE FEEDS	0.04 - 0.485 mm

TAIL STOCK	
TAIL STOCK SPINDLE DIAMETER	60.3 mm
TAPER IN TAIL STOCK QUILL	MT - 4

TRAVEL AND TOOLS	
CROSS SLIDE TRAVEL	280 mm
COMPOUND SLIDE TRAVEL	145 mm
TAIL STOCK SLEEVE TRAVEL	170 mm
TOOL POST SQUARE	120 mm
TOOL SHANK SIZE	25 mm
SUITABLE ELECTRICAL HP	3 HP / 5 HP (3 phase)*

STANDARD ACCESSORIES :

- CHUCK BACK PLATE
- CENTRE ADAPTER
- DEAD CENTRES 2 NOS
- TOOL POST SPANNER
- MOTOR PULLEY
- THREAD DIAL INDICATOR
- CHANGE GEAR SET
- CHIP TRAY

OPTIONAL ACCESSORIES :

- INDEPENDENT CHUCK
- SELF CENTRING CHUCK
- CHUCK BACK PLATE EXTRA
- STEADY REST
- FOLLOW REST
- FACE PLATE
- CARRIER PLATE
- TAPER TURNING ATTACHMENT
- COOLANT PUMP WITH TANK AND FITTINGS
- REAR TOOL POST
- ELECTRICALS (MOTOR, WIRING, SWITCH, V-BELTS AND FITTINGS)
- NORTON GEAR BOX (SINGLE OR DOUBLE SHAFT)
- SPLASH GUARD
- FOUNDATION ROUND PLATE WITH LEVELLING BOLTS
- QUICK CHANGE TOOL POST
- KEY WAY ATTACHMENT

NOTE : As improvements are constantly made in our machines, the above illustrations, specifications, dimensions and technical data are subject to modifications and change without prior notice and not binding on us.



LATHE
ISO 9001:2015
CERTIFIED COMPANY

**CONE PULLEY HEAVY DUTY
LATHE MACHINE
MODEL - VH-15**

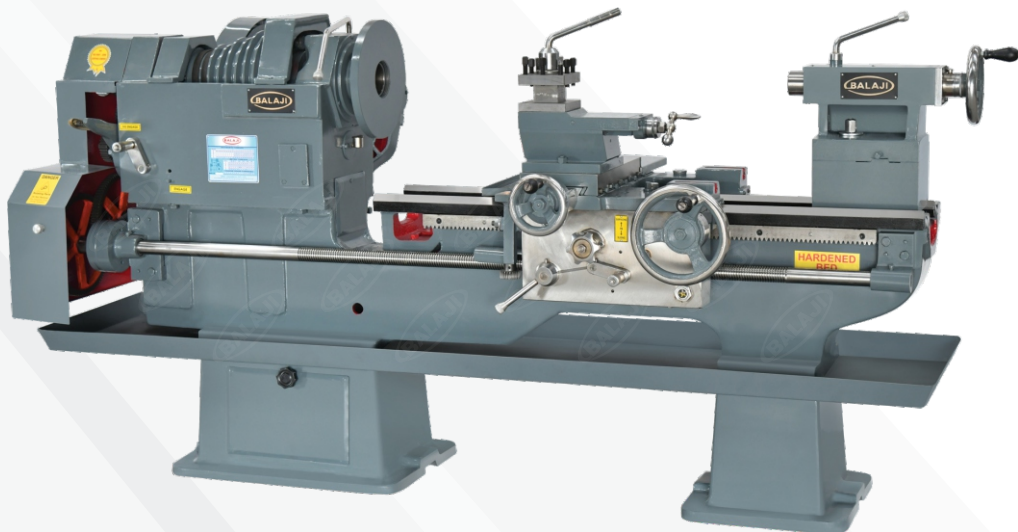



MODEL - VH-15 CONE PULLEY HEAVY DUTY LATHE MACHINE : TECHNICAL SPECIFICATIONS

BED											
LENGTH OF BED	7' (2100 mm)	9' (2740 mm)	10' (3040 mm)	12' (3650 mm)	14' (4260 mm)	16' (4850 mm)	18' (5450 mm)	20' (6050 mm)	22' (6650 mm)	24' (7250 mm)	26' (7850 mm)
ADMIT BETWEEN CENTRE	1000 mm	1600 mm	1900 mm	2500 mm	3100 mm	3700 mm	4300 mm	4900 mm	5500 mm	6100 mm	6700 mm

TYPE OF BED	Hardened Bed Ways		
HEIGHT OF CENTRE	304 mm (12")	355 mm (14")	380 mm (15")
SWING OVER BED	580 mm	680 mm	730 mm
SWING OVER CROSS SLIDE	390 mm	490 mm	540 mm
SWING IN GAP	890 mm	990 mm	1040 mm
WIDTH OF BED	375 mm		
LENGTH OF GAP IN FRONT OF FACE PLATE	200 mm		

MAIN SPINDLE	
NO. OF SPINDLE SPEED	8
SPINDLE SPEED RANGE	40 to 340 RPM*
TAPER IN SPINDLE	MT-6
SPINDLE BORE	79 mm / 104 mm / 129 mm
SPINDLE NOSE	Threaded
SPINDLE THREADS	6 TPI

THREADS	
LEAD SCREW DIAMETER / PITCH	38 mm / 4 TPI
NOS. OF THREADS/RANGE (WITHOUT NORTON GEAR BOX)	METRIC : 13 / 1 mm to 6 mm PITCH INCH : 19 / 2 to 24 TPI
NOS. OF THREADS/RANGE (FOR FULL NORTON GEAR BOX)	METRIC : 24 / 0.5 mm to 15 mm PITCH INCH : 44 / 2 to 60 TPI
NO. OF FEEDS	19
RANGE OF LONGITUDINAL FEEDS	0.165 - 1.996 mm
RANGE OF TRANSVERSE FEEDS	0.04 - 0.485 mm

TAIL STOCK	
TAIL STOCK SPINDLE DIAMETER	60.3 mm
TAPER IN TAIL STOCK QUILL	MT - 4

TRAVEL AND TOOLS	
CROSS SLIDE TRAVEL	325 mm
COMPOUND SLIDE TRAVEL	190 mm
TAIL STOCK SLEEVE TRAVEL	170 mm
TOOL POST SQUARE	145 mm
TOOL SHANK SIZE	25 mm
SUITABLE ELECTRICAL HP	5 HP / 7.5 HP (3 phase)*

STANDARD ACCESSORIES :

- CHUCK BACK PLATE
- CENTRE ADAPTER
- DEAD CENTRES 2 NOS
- TOOL POST SPANNER
- MOTOR PULLEY
- THREAD DIAL INDICATOR
- CHANGE GEAR SET
- CHIP TRAY

OPTIONAL ACCESSORIES :

- INDEPENDENT CHUCK
- SELF CENTRING CHUCK
- CHUCK BACK PLATE EXTRA
- STEADY REST
- FOLLOW REST
- FACE PLATE
- CARRIER PLATE
- TAPER TURNING ATTACHMENT
- COOLANT PUMP WITH TANK AND FITTINGS
- REAR TOOL POST
- ELECTRICALS (MOTOR, WIRING, SWITCH, V-BELTS AND FITTINGS)
- NORTON GEAR BOX (SINGLE OR DOUBLE SHAFT)
- SPLASH GUARD
- FOUNDATION ROUND PLATE WITH LEVELLING BOLTS
- QUICK CHANGE TOOL POST
- KEY WAY ATTACHMENT

NOTE : As improvements are constantly made in our machines, the above illustrations, specifications, dimensions and technical data are subject to modifications and change without prior notice and not binding on us.



LATHE

ISO 9001:2015
CERTIFIED COMPANY

**CONE PULLEY
EXTRA HEAVY DUTY LATHE MACHINE
VH-18**

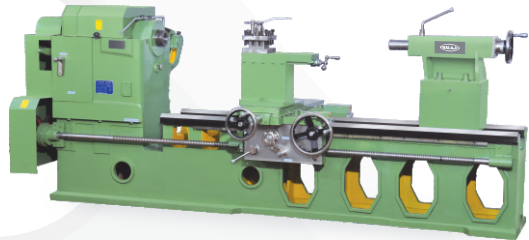
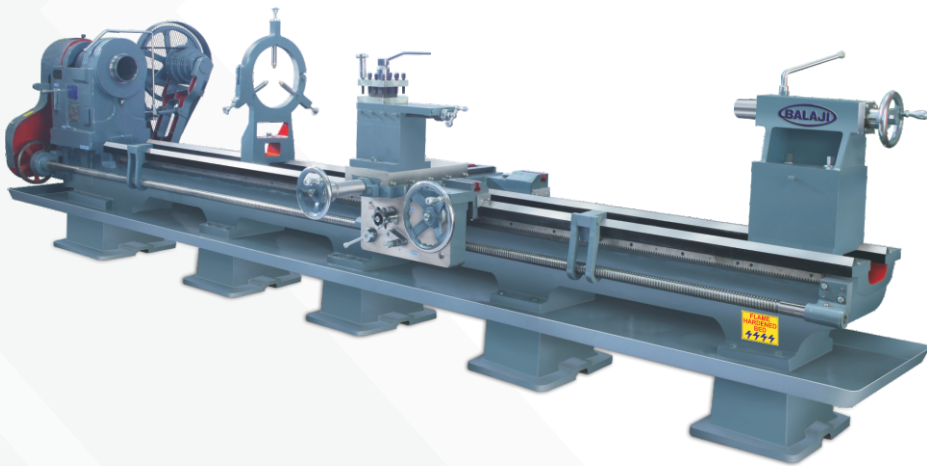



MODEL - VH-18 CONE PULLEY EXTRA HEAVY DUTY LATHE MACHINE : TECHNICAL SPECIFICATIONS

BED											
LENGTH OF BED	7' (2100 mm)	9' (2740 mm)	10' (3040 mm)	12' (3650 mm)	14' (4260 mm)	16' (4850 mm)	18' (5450 mm)	20' (6050 mm)	22' (6650 mm)	24' (7250 mm)	26' (7850 mm)
ADMIT BETWEEN CENTRE	700 mm	1300 mm	1600 mm	2200 mm	2800 mm	3400 mm	4000 mm	4600 mm	5200 mm	5800 mm	6400 mm

TYPE OF BED	Hardened Bed Ways	
HEIGHT OF CENTRE	406 mm (16")	457 mm (18")
SWING OVER BED	785 mm	885 mm
SWING OVER CROSS SLIDE	550 mm	650 mm
SWING IN GAP	1100 mm	1200 mm
WIDTH OF BED	455 mm	
LENGTH OF GAP IN FRONT OF FACE PLATE	250 mm*	

MAIN SPINDLE	
NO. OF SPINDLE SPEED	8
SPINDLE SPEED RANGE	20 to 200 RPM*
TAPER IN SPINDLE	MT-6
SPINDLE BORE	79 mm / 104 mm / 129 mm / 152 mm
SPINDLE NOSE	Threaded
SPINDLE THREADS	6 TPI

THREADS	
LEAD SCREW DIAMETER / PITCH	44.4 mm / 2 TPI
NOS. OF THREADS/RANGE (WITHOUT NORTON GEAR BOX)	METRIC : 13 / 1 mm to 6 mm PITCH INCH : 20 / 1 to 24 TPI
NOS. OF THREADS/RANGE (FOR FULL NORTON GEAR BOX)	METRIC : 24 / 0.5 mm to 15 mm PITCH INCH : 44 / 2 to 60 TPI
NO. OF FEEDS	19
RANGE OF LONGITUDINAL FEEDS	0.16 - 2 mm
RANGE OF TRANSVERSE FEEDS	0.04 - 0.5 mm

TAIL STOCK	
TAIL STOCK SPINDLE DIAMETER	76 mm
TAPER IN TAIL STOCK QUILL	MT - 5

TRAVEL AND TOOLS	
CROSS SLIDE TRAVEL	440 mm*
COMPOUND SLIDE TRAVEL	200 mm
TAIL STOCK SLEEVE TRAVEL	250 mm
TOOL POST SQUARE	150 mm
TOOL SHANK SIZE	38 mm
SUITABLE ELECTRICAL HP	7.5 HP (3 phase) (960 RPM)

STANDARD ACCESSORIES :

- CHUCK BACK PLATE
- CENTRE ADAPTER
- DEAD CENTRES 2 NOS
- TOOL POST SPANNER
- MOTOR PULLEY
- THREAD DIAL INDICATOR
- CHANGE GEAR SET
- CHIP TRAY

OPTIONAL ACCESSORIES :

- INDEPENDENT CHUCK
- SELF CENTRING CHUCK
- CHUCK BACK PLATE EXTRA
- STEADY REST
- FOLLOW REST
- FACE PLATE
- CARRIER PLATE
- TAPER TURNING ATTACHMENT
- COOLANT PUMP WITH TANK AND FITTINGS
- ELECTRICALS (MOTOR, WIRING, SWITCH, V-BELTS AND FITTINGS)
- NORTON GEAR BOX (SINGLE OR DOUBLE SHAFT)
- SPLASH GUARD
- FOUNDATION ROUND PLATE WITH LEVELLING BOLTS
- QUICK CHANGE TOOL POST
- KEY WAY ATTACHMENT

NOTE : As improvements are constantly made in our machines, the above illustrations, specifications, dimensions and technical data are subject to modifications and change without prior notice and not binding on us.



LATHE

ISO 9001:2015
CERTIFIED COMPANY

**CONE PULLEY
EXTRA HEAVY DUTY LATHE MACHINE
VH-20**

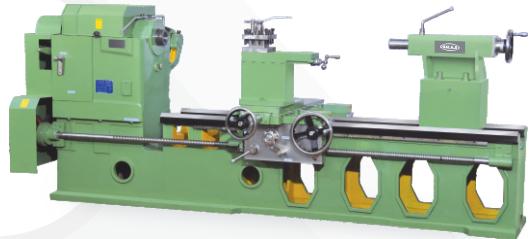
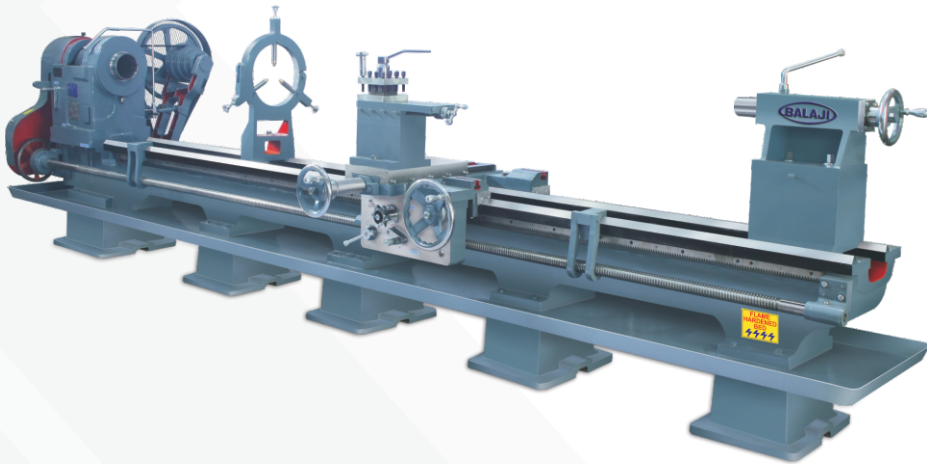



MODEL - VH-20 CONE PULLEY EXTRA HEAVY DUTY LATHE MACHINE : TECHNICAL SPECIFICATIONS

BED											
LENGTH OF BED	7' (2100 mm)	9' (2740 mm)	10' (3040 mm)	12' (3650 mm)	14' (4260 mm)	16' (4850 mm)	18' (5450 mm)	20' (6050 mm)	22' (6650 mm)	24' (7250 mm)	26' (7850 mm)
ADMIT BETWEEN CENTRE	700 mm	1300 mm	1600 mm	2200 mm	2800 mm	3400 mm	4000 mm	4600 mm	5200 mm	5800 mm	6400 mm

TYPE OF BED	Hardened Bed Ways	
HEIGHT OF CENTRE	457 mm (18")	508 mm (20")
SWING OVER BED	885 mm	985 mm
SWING OVER CROSS SLIDE	650 mm	750 mm
SWING IN GAP	1200 mm	1300 mm
WIDTH OF BED	508 mm	
LENGTH OF GAP IN FRONT OF FACE PLATE	250 mm*	

MAIN SPINDLE	
NO. OF SPINDLE SPEED	8
SPINDLE SPEED RANGE	20 to 200 RPM*
TAPER IN SPINDLE	MT-6
SPINDLE BORE	79 mm / 104 mm / 129 mm / 152 mm
SPINDLE NOSE	Threaded
SPINDLE THREADS	6 TPI

THREADS	
LEAD SCREW DIAMETER / PITCH	44.4 mm / 2 TPI
NOS. OF THREADS/RANGE (WITHOUT NORTON GEAR BOX)	METRIC : 13 / 1 mm to 6 mm PITCH INCH : 20 / 1 to 24 TPI
NOS. OF THREADS/RANGE (FOR FULL NORTON GEAR BOX)	METRIC : 24 / 0.5 mm to 15 mm PITCH INCH : 44 / 2 to 60 TPI
NO. OF FEEDS	19
RANGE OF LONGITUDINAL FEEDS	0.16 - 2 mm
RANGE OF TRANSVERSE FEEDS	0.04 - 0.5 mm

TAIL STOCK	
TAIL STOCK SPINDLE DIAMETER	76 mm
TAPER IN TAIL STOCK QUILL	MT - 5

TRAVEL AND TOOLS	
CROSS SLIDE TRAVEL	490 mm
COMPOUND SLIDE TRAVEL	200 mm
TAIL STOCK SLEEVE TRAVEL	250 mm
TOOL POST SQUARE	150 mm
TOOL SHANK SIZE	38 mm
SUITABLE ELECTRICAL HP	7.5 HP (3 phase) (960 RPM)

STANDARD ACCESSORIES :

- CHUCK BACK PLATE
- CENTRE ADAPTER
- DEAD CENTRES 2 NOS
- TOOL POST SPANNER
- MOTOR PULLEY
- THREAD DIAL INDICATOR
- CHANGE GEAR SET
- CHIP TRAY

OPTIONAL ACCESSORIES :

- INDEPENDENT CHUCK
- SELF CENTRING CHUCK
- CHUCK BACK PLATE EXTRA
- STEADY REST
- FOLLOW REST
- FACE PLATE
- CARRIER PLATE
- TAPER TURNING ATTACHMENT
- COOLANT PUMP WITH TANK AND FITTINGS
- ELECTRICALS (MOTOR, WIRING, SWITCH, V-BELTS AND FITTINGS)
- NORTON GEAR BOX (SINGLE OR DOUBLE SHAFT)
- SPLASH GUARD
- FOUNDATION ROUND PLATE WITH LEVELLING BOLTS
- QUICK CHANGE TOOL POST
- KEY WAY ATTACHMENT

NOTE : As improvements are constantly made in our machines, the above illustrations, specifications, dimensions and technical data are subject to modifications and change without prior notice and not binding on us.



LATHE
ISO 9001:2015
CERTIFIED COMPANY

CONE PULLEY
EXTRA HEAVY DUTY LATHE MACHINE
VH-22

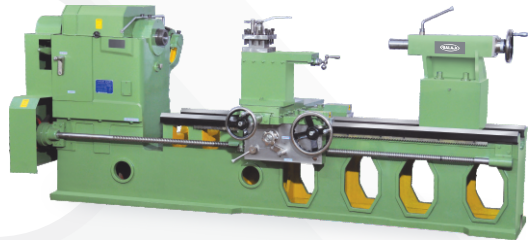
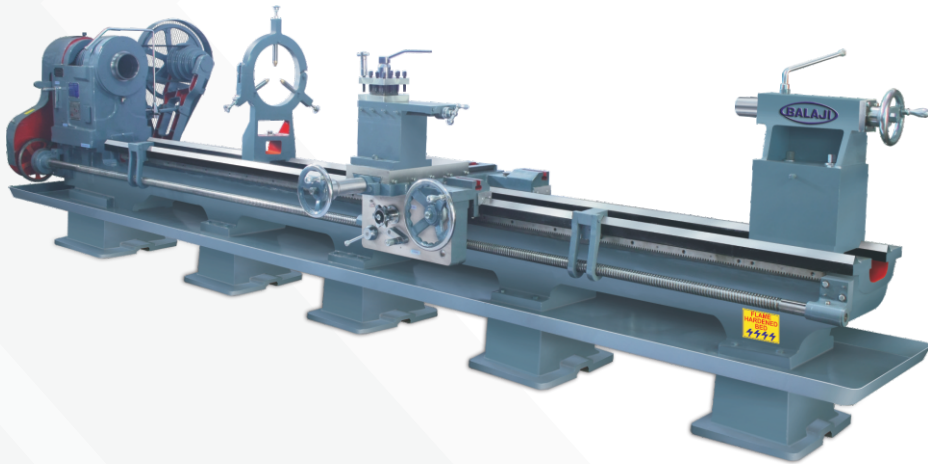



MODEL - VH-22 CONE PULLEY EXTRA HEAVY DUTY LATHE MACHINE : TECHNICAL SPECIFICATIONS

BED											
LENGTH OF BED	7' (2100 mm)	9' (2740 mm)	10' (3040 mm)	12' (3650 mm)	14' (4260 mm)	16' (4850 mm)	18' (5450 mm)	20' (6050 mm)	22' (6650 mm)	24' (7250 mm)	26' (7850 mm)
ADMIT BETWEEN CENTRE	700 mm	1300 mm	1600 mm	2200 mm	2800 mm	3400 mm	4000 mm	4600 mm	5200 mm	5800 mm	6400 mm

TYPE OF BED	Hardened Bed Ways	
HEIGHT OF CENTRE	508 mm (20")	558 mm (22")
SWING OVER BED	985 mm	1085 mm
SWING OVER CROSS SLIDE	680 mm	780 mm
SWING IN GAP	1300 mm	1400 mm
WIDTH OF BED	558 mm	
LENGTH OF GAP IN FRONT OF FACE PLATE	250 mm*	

MAIN SPINDLE	
NO. OF SPINDLE SPEED	8
SPINDLE SPEED RANGE	20 to 200 RPM*
TAPER IN SPINDLE	MT-6
SPINDLE BORE	79 mm / 104 mm / 129 mm / 152 mm
SPINDLE NOSE	Threaded
SPINDLE THREADS	6 TPI

THREADS	
LEAD SCREW DIAMETER / PITCH	44.4 mm / 2 TPI
NOS. OF THREADS/RANGE (WITHOUT NORTON GEAR BOX)	METRIC : 13 / 1 mm to 6 mm PITCH INCH : 20 / 1 to 24 TPI
NOS. OF THREADS/RANGE (FOR FULL NORTON GEAR BOX)	METRIC : 24 / 0.5 mm to 15 mm PITCH INCH : 44 / 2 to 60 TPI
NO. OF FEEDS	19
RANGE OF LONGITUDINAL FEEDS	0.16 - 2 mm
RANGE OF TRANSVERSE FEEDS	0.04 - 0.5 mm

TAIL STOCK	
TAIL STOCK SPINDLE DIAMETER	76 mm
TAPER IN TAIL STOCK QUILL	MT - 5

TRAVEL AND TOOLS	
CROSS SLIDE TRAVEL	550 mm*
COMPOUND SLIDE TRAVEL	250 mm
TAIL STOCK SLEEVE TRAVEL	250 mm
TOOL POST SQUARE	175 mm
TOOL SHANK SIZE	38 mm
SUITABLE ELECTRICAL HP	7.5 HP (3 phase) (960 RPM)

STANDARD ACCESSORIES :

- CHUCK BACK PLATE
- CENTRE ADAPTER
- DEAD CENTRES 2 NOS
- TOOL POST SPANNER
- MOTOR PULLEY
- THREAD DIAL INDICATOR
- CHANGE GEAR SET
- CHIP TRAY

OPTIONAL ACCESSORIES :

- INDEPENDENT CHUCK
- SELF CENTRING CHUCK
- CHUCK BACK PLATE EXTRA
- STEADY REST
- FOLLOW REST
- FACE PLATE
- CARRIER PLATE
- TAPER TURNING ATTACHMENT
- COOLANT PUMP WITH TANK AND FITTINGS
- ELECTRICALS (MOTOR, WIRING, SWITCH, V-BELTS AND FITTINGS)
- NORTON GEAR BOX (SINGLE OR DOUBLE SHAFT)
- SPLASH GUARD
- FOUNDATION ROUND PLATE WITH LEVELLING BOLTS
- QUICK CHANGE TOOL POST
- KEY WAY ATTACHMENT

NOTE : As improvements are constantly made in our machines, the above illustrations, specifications, dimensions and technical data are subject to modifications and change without prior notice and not binding on us.



LATHE

ISO 9001:2015
CERTIFIED COMPANY

**CONE PULLEY
EXTRA HEAVY DUTY LATHE MACHINE
VH-24**

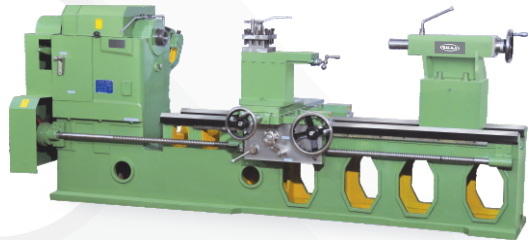
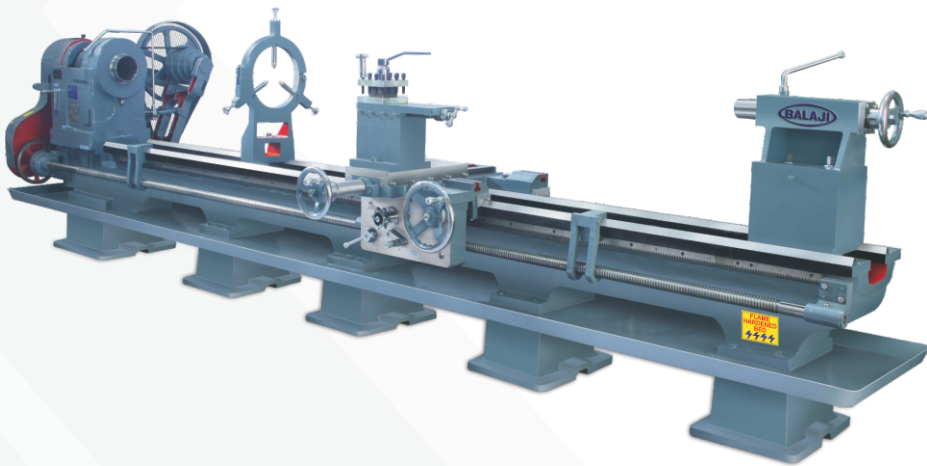



MODEL - VH-24 CONE PULLEY EXTRA HEAVY DUTY LATHE MACHINE : TECHNICAL SPECIFICATIONS

BED											
LENGTH OF BED	7' (2100 mm)	9' (2740 mm)	10' (3040 mm)	12' (3650 mm)	14' (4260 mm)	16' (4850 mm)	18' (5450 mm)	20' (6050 mm)	22' (6650 mm)	24' (7250 mm)	26' (7850 mm)
ADMIT BETWEEN CENTRE	550 mm	1150 mm	1450 mm	2050 mm	2650 mm	3250 mm	3850 mm	4450 mm	5050 mm	5650 mm	6250 mm

TYPE OF BED	Hardened Bed Ways	
HEIGHT OF CENTRE	558 mm (22")	609 mm (24")
SWING OVER BED	1085 mm	1185 mm
SWING OVER CROSS SLIDE	775 mm	875 mm
SWING IN GAP	1400 mm	1500 mm
WIDTH OF BED	609 mm	
LENGTH OF GAP IN FRONT OF FACE PLATE	250 mm*	

MAIN SPINDLE	
NO. OF SPINDLE SPEED	8
SPINDLE SPEED RANGE	15 to 150 RPM*
TAPER IN SPINDLE	MT-6
SPINDLE BORE	79 mm / 104 mm / 129 mm / 152 mm
SPINDLE NOSE	Threaded
SPINDLE THREADS	6 TPI

THREADS	
LEAD SCREW DIAMETER / PITCH	44.4 mm / 2 TPI
NOS. OF THREADS/RANGE (WITHOUT NORTON GEAR BOX)	METRIC : 13 / 1 mm to 6 mm PITCH INCH : 20 / 1 to 24 TPI
NOS. OF THREADS/RANGE (FOR FULL NORTON GEAR BOX)	METRIC : 24 / 0.5 mm to 15 mm PITCH INCH : 44 / 2 to 60 TPI
NO. OF FEEDS	19
RANGE OF LONGITUDINAL FEEDS	0.16 - 2 mm
RANGE OF TRANSVERSE FEEDS	0.04 - 0.5 mm

TAIL STOCK	
TAIL STOCK SPINDLE DIAMETER	100 mm
TAPER IN TAIL STOCK QUILL	MT - 5

TRAVEL AND TOOLS	
CROSS SLIDE TRAVEL	600 mm*
COMPOUND SLIDE TRAVEL	250 mm
TAIL STOCK SLEEVE TRAVEL	250 mm
TOOL POST SQUARE	200 mm
TOOL SHANK SIZE	38 mm
SUITABLE ELECTRICAL HP	7.5 HP / 10HP (960 RPM)

STANDARD ACCESSORIES :

- CHUCK BACK PLATE
- CENTRE ADAPTER
- DEAD CENTRES 2 NOS
- TOOL POST SPANNER
- MOTOR PULLEY
- THREAD DIAL INDICATOR
- CHANGE GEAR SET
- CHIP TRAY

OPTIONAL ACCESSORIES :

- INDEPENDENT CHUCK
- SELF CENTRING CHUCK
- CHUCK BACK PLATE EXTRA
- STEADY REST
- FOLLOW REST
- FACE PLATE
- CARRIER PLATE
- TAPER TURNING ATTACHMENT
- COOLANT PUMP WITH TANK AND FITTINGS
- ELECTRICALS (MOTOR, WIRING, SWITCH, V-BELTS AND FITTINGS)
- NORTON GEAR BOX (SINGLE OR DOUBLE SHAFT)
- SPLASH GUARD
- FOUNDATION ROUND PLATE WITH LEVELLING BOLTS
- QUICK CHANGE TOOL POST
- KEY WAY ATTACHMENT

NOTE : As improvements are constantly made in our machines, the above illustrations, specifications, dimensions and technical data are subject to modifications and change without prior notice and not binding on us.



LATHE
ISO 9001:2015
CERTIFIED COMPANY

CONE PULLEY
EXTRA HEAVY DUTY LATHE MACHINE
VH-26

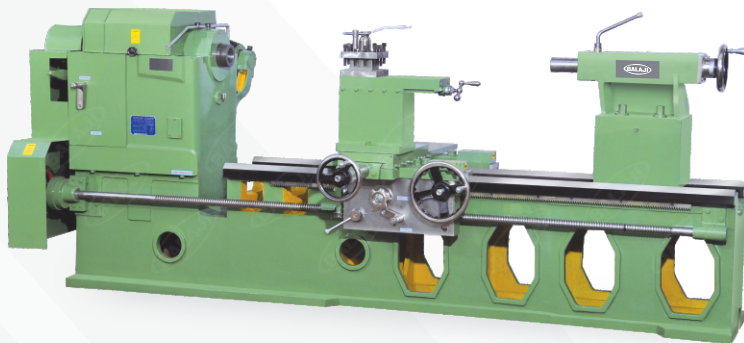



MODEL - VH-26 CONE PULLEY EXTRA HEAVY DUTY LATHE MACHINE : TECHNICAL SPECIFICATIONS

BED											
LENGTH OF BED	7' (2100 mm)	9' (2740 mm)	10' (3040 mm)	12' (3650 mm)	14' (4260 mm)	16' (4850 mm)	18' (5450 mm)	20' (6050 mm)	22' (6650 mm)	24' (7250 mm)	26' (7850 mm)
ADMIT BETWEEN CENTRE	500 mm	1100 mm	1400 mm	2000 mm	2600 mm	3200 mm	3800 mm	4400 mm	5000 mm	5600 mm	6200 mm

TYPE OF BED	Planner Type Hardened Bed Ways
HEIGHT OF CENTRE	660 mm (26")
SWING OVER BED	1285 mm
SWING OVER CROSS SLIDE	975 mm
SWING IN GAP	1600 mm
WIDTH OF BED	660 mm
LENGTH OF GAP IN FRONT OF FACE PLATE	250 mm

MAIN SPINDLE	
NO. OF SPINDLE SPEED	8
SPINDLE SPEED RANGE	15 to 150 RPM*
TAPER IN SPINDLE	MT-6
SPINDLE BORE	104 mm / 129 mm / 152 mm / 178 mm
SPINDLE NOSE	Threaded
SPINDLE THREADS	6 TPI

THREADS	
LEAD SCREW DIAMETER / PITCH	50.8 mm / 2 TPI
NOS. OF THREADS/RANGE (WITHOUT NORTON GEAR BOX)	METRIC : 13 / 1 mm to 6 mm PITCH INCH : 20 / 1 to 24 TPI
NOS. OF THREADS/RANGE (FOR FULL NORTON GEAR BOX)	METRIC : 24 / 0.5 mm to 15 mm PITCH INCH : 44 / 2 to 60 TPI
NO. OF FEEDS	19
RANGE OF LONGITUDINAL FEEDS	0.16 - 2 mm
RANGE OF TRANSVERSE FEEDS	0.04 - 0.5 mm

TAIL STOCK	
TAIL STOCK SPINDLE DIAMETER	100 mm
TAPER IN TAIL STOCK QUILL	MT - 5

TRAVEL AND TOOLS	
CROSS SLIDE TRAVEL	600 mm*
COMPOUND SLIDE TRAVEL	320 mm
TAIL STOCK SLEEVE TRAVEL	400 mm
TOOL POST SQUARE	200 mm
TOOL SHANK SIZE	38 mm
SUITABLE ELECTRICAL HP	7.5 HP / 10HP (960 RPM)

STANDARD ACCESSORIES :

- CHUCK BACK PLATE
- CENTRE ADAPTER
- DEAD CENTRES 2 NOS
- TOOL POST SPANNER
- MOTOR PULLEY
- THREAD DIAL INDICATOR
- CHANGE GEAR SET
- CHIP TRAY

OPTIONAL ACCESSORIES :

- INDEPENDENT CHUCK
- SELF CENTRING CHUCK
- CHUCK BACK PLATE EXTRA
- STEADY REST
- FOLLOW REST
- FACE PLATE
- CARRIER PLATE
- TAPER TURNING ATTACHMENT
- COOLANT PUMP WITH TANK AND FITTINGS
- ELECTRICALS (MOTOR, WIRING, SWITCH, V-BELTS AND FITTINGS)
- NORTON GEAR BOX (SINGLE OR DOUBLE SHAFT)
- SPLASH GUARD
- FOUNDATION ROUND PLATE WITH LEVELLING BOLTS
- QUICK CHANGE TOOL POST
- KEYWAY ATTACHMENT

NOTE : As improvements are constantly made in our machines, the above illustrations, specifications, dimensions and technical data are subject to modifications and change without prior notice and not binding on us.



LATHE
ISO 9001:2015
CERTIFIED COMPANY

CONE PULLEY
EXTRA HEAVY DUTY LATHE MACHINE
VH-30

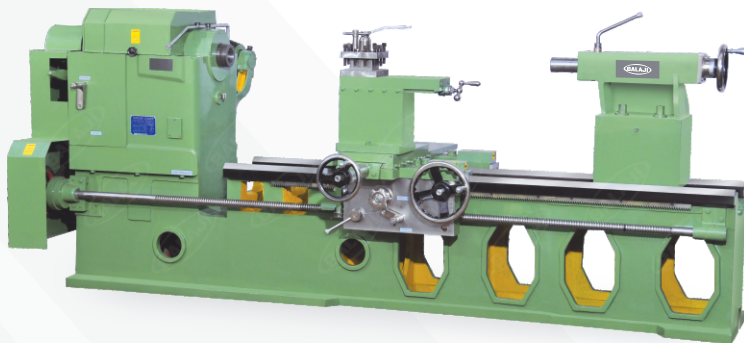



MODEL - VH-30 CONE PULLEY EXTRA HEAVY DUTY LATHE MACHINE : TECHNICAL SPECIFICATIONS

BED											
LENGTH OF BED	9' (2740 mm)	10' (3040 mm)	12' (3650 mm)	14' (4260 mm)	16' (4850 mm)	18' (5450 mm)	20' (6050 mm)	22' (6650 mm)	24' (7250 mm)	26' (7850 mm)	28' (8450 mm)
ADMIT BETWEEN CENTRE	900 mm	1200 mm	1800 mm	2400 mm	3000 mm	3600 mm	4200 mm	4800 mm	5400 mm	6000 mm	6600 mm

TYPE OF BED	Planner Type Hardened Bed Ways
HEIGHT OF CENTRE	760 mm (30")
SWING OVER BED	1450 mm
SWING OVER CROSS SLIDE	1100 mm
SWING IN GAP	1800 mm
WIDTH OF BED	760 mm
LENGTH OF GAP IN FRONT OF FACE PLATE	250 mm

MAIN SPINDLE	
NO. OF SPINDLE SPEED	8
SPINDLE SPEED RANGE	15 to 150 RPM*
TAPER IN SPINDLE	MT-6
SPINDLE BORE	104 mm / 129 mm / 152 mm / 178 mm
SPINDLE NOSE	Threaded
SPINDLE THREADS	6 TPI

THREADS	
LEAD SCREW DIAMETER / PITCH	50.8 mm / 2 TPI
NOS. OF THREADS/RANGE (WITHOUT NORTON GEAR BOX)	METRIC : 13 / 1 mm to 6 mm PITCH INCH : 20 / 1 to 24 TPI
NOS. OF THREADS/RANGE (FOR FULL NORTON GEAR BOX)	METRIC : 24 / 0.5 mm to 15 mm PITCH INCH : 44 / 2 to 60 TPI
NO. OF FEEDS	19
RANGE OF LONGITUDINAL FEEDS	0.16 - 2 mm
RANGE OF TRANSVERSE FEEDS	0.04 - 0.5 mm

TAIL STOCK	
TAIL STOCK SPINDLE DIAMETER	100 mm
TAPER IN TAIL STOCK QUILL	MT - 5

TRAVEL AND TOOLS	
CROSS SLIDE TRAVEL	700 mm*
COMPOUND SLIDE TRAVEL	320 mm
TAIL STOCK SLEEVE TRAVEL	400 mm
TOOL POST SQUARE	200 mm
TOOL SHANK SIZE	38 mm
SUITABLE ELECTRICAL HP	7.5 HP / 10HP (960 RPM)

STANDARD ACCESSORIES :

- CHUCK BACK PLATE
- CENTRE ADAPTER
- DEAD CENTRES 2 NOS
- TOOL POST SPANNER
- MOTOR PULLEY
- THREAD DIAL INDICATOR
- CHANGE GEAR SET
- CHIP TRAY

OPTIONAL ACCESSORIES :

- INDEPENDENT CHUCK
- SELF CENTRING CHUCK
- CHUCK BACK PLATE EXTRA
- STEADY REST
- FOLLOW REST
- FACE PLATE
- CARRIER PLATE
- TAPER TURNING ATTACHMENT
- COOLANT PUMP WITH TANK AND FITTINGS
- ELECTRICALS (MOTOR, WIRING, SWITCH, V-BELTS AND FITTINGS)
- NORTON GEAR BOX (SINGLE OR DOUBLE SHAFT)
- SPLASH GUARD
- FOUNDATION ROUND PLATE WITH LEVELLING BOLTS
- QUICK CHANGE TOOL POST
- KEYWAY ATTACHMENT

NOTE : As improvements are constantly made in our machines, the above illustrations, specifications, dimensions and technical data are subject to modifications and change without prior notice and not binding on us.



LATHE
ISO 9001:2015
CERTIFIED COMPANY

**GEARED HEAD LIGHT DUTY
LATHE MACHINE
MODEL - VGL-165**

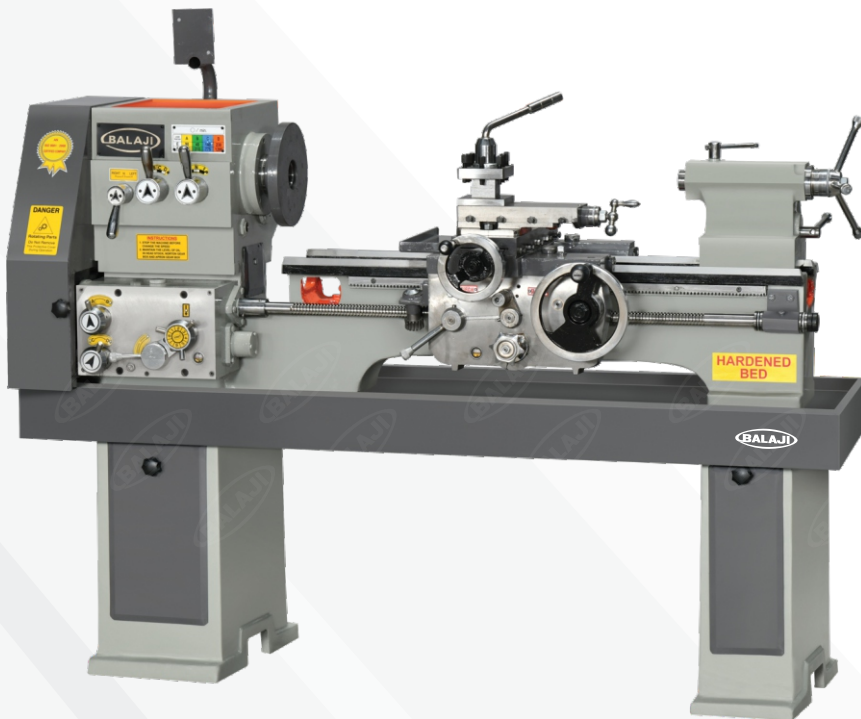



MODEL - VGL-165 GEARED HEAD LIGHT DUTY LATHE MACHINE : TECHNICAL SPECIFICATIONS

BED	
LENGTH OF BED	1370 mm (4'-6")
ADMIT BETWEEN CENTRE	660 mm
TYPE OF BED	Hardened Bed Ways
SWING OVER BED	325 mm
HEIGHT OF CENTRE	165 mm
WIDTH OF BED	240 mm
SWING OVER CROSS SLIDE	175 mm
SWING IN GAP	500 mm
LENGTH OF GAP IN FRONT OF FACE PLATE	115 mm

MAIN SPINDLE	
NO. OF SPINDLE SPEED	8
SPINDLE SPEED RANGE	40 to 1200 RPM
TAPER IN SPINDLE	MT-5
SPINDLE BORE	38 mm
SPINDLE NOSE	Threaded / A2 - 4

THREADS	
LEAD SCREW DIAMETER / PITCH	25.4 mm / 4 TPI
NOS. OF THREADS/RANGE (FOR FULL NORTON GEAR BOX)	METRIC : 24 / 0.5 mm to 15 mm PITCH INCH : 44 / 2 to 60 TPI
NO. OF FEEDS	40
RANGE OF LONGITUDINAL FEEDS	0.066 - 2 mm
RANGE OF TRANSVERSE FEEDS	0.0165 - 0.50 mm

TAIL STOCK	
TAIL STOCK SPINDLE DIAMETER	38.1 mm
TAPER IN TAIL STOCK QUILL	MT - 3

TRAVEL AND TOOLS	
CROSS SLIDE TRAVEL	175 mm
COMPOUND SLIDE TRAVEL	125 mm
TAIL STOCK SLEEVE TRAVEL	120 mm
TOOL POST SQUARE	88 x 88 mm
TOOL SHANK SIZE	20 mm
SUITABLE ELECTRICAL HP	1 HP (3 phase)

STANDARD ACCESSORIES :
■ CHUCK BACK PLATE
■ CENTRE ADAPTER
■ DEAD CENTRES 2 NOS
■ TOOL POST SPANNER
■ MOTOR PULLEY
■ THREAD DIAL INDICATOR
■ CHANGE GEAR SET
■ CHIP TRAY
■ NORTON GEAR BOX WITH SINGLE SHAFT

OPTIONAL ACCESSORIES :
■ INDEPENDENT CHUCK
■ SELF CENTRING CHUCK
■ CHUCK BACK PLATE EXTRA
■ STEADY REST
■ FOLLOW REST
■ FACE PLATE
■ CARRIER PLATE
■ TAPER TURNING ATTACHMENT
■ COOLANT PUMP WITH TANK AND FITTINGS
■ REAR TOOL POST
■ ELECTRICALS (MOTOR, WIRING, SWITCH, V-BELTS AND FITTINGS)
■ SPLASH GUARD
■ FOUNDATION ROUND PLATE WITH LEVELLING BOLTS
■ QUICK CHANGE TOOL POST
■ KEY WAY ATTACHMENT

NOTE : As improvements are constantly made in our machines, the above illustrations, specifications, dimensions and technical data are subject to modifications and change without prior notice and not binding on us.



LATHE
ISO 9001:2015
CERTIFIED COMPANY

GEARED HEAD MEDIUM DUTY
LATHE MACHINE
VGM-215-DELUXE





VGM-215 GEARED HEAD MEDIUM DUTY LATHE MACHINE - DELUXE : TECHNICAL SPECIFICATIONS

BED	
LENGTH OF BED	1825 mm (6')
ADMIT BETWEEN CENTRE	1000 mm
TYPE OF BED	Hardened Bed Ways
SWING OVER BED	420 mm
HEIGHT OF CENTRE	215 mm
WIDTH OF BED	277 mm
SWING OVER CROSS SLIDE	240 mm
SWING IN GAP	620 mm
LENGTH OF GAP IN FRONT OF FACE PLATE	125 mm

MAIN SPINDLE	
NO. OF SPINDLE SPEED	8
SPINDLE SPEED RANGE	40 to 1200 RPM
TAPER IN SPINDLE	MT-5
SPINDLE BORE	38 mm
SPINDLE NOSE	A2 - 4

THREADS	
LEAD SCREW DIAMETER / PITCH	31.75 mm / 4 TPI
NOS. OF THREADS/RANGE (FOR FULL NORTON GEAR BOX)	METRIC : 24 / 0.5 mm to 15 mm PITCH INCH : 44 / 2 to 60 TPI
NO. OF FEEDS	40
RANGE OF LONGITUDINAL FEEDS	0.066 - 2 mm
RANGE OF TRANSVERSE FEEDS	0.0165 - 0.5 mm

TAIL STOCK	
TAIL STOCK SPINDLE DIAMETER	50.8 mm
TAPER IN TAIL STOCK QUILL	MT - 4

TRAVEL AND TOOLS	
CROSS SLIDE TRAVEL	230 mm
COMPOUND SLIDE TRAVEL	140 mm
TAIL STOCK SLEEVE TRAVEL	140 mm
TOOL POST SQUARE	100 mm
TOOL SHANK SIZE	20 mm
SUITABLE ELECTRICAL HP	2 HP (3 phase)

STANDARD ACCESSORIES :

- CHUCK BACK PLATE
- CENTRE ADAPTER
- DEAD CENTRES 2 NOS
- TOOL POST SPANNER
- MOTOR PULLEY
- THREAD DIAL INDICATOR
- CHANGE GEAR SET
- CHIP TRAY
- NORTON GEAR BOX WITH DOUBLE SHAFT

OPTIONAL ACCESSORIES :

- INDEPENDENT CHUCK
- SELF CENTRING CHUCK
- CHUCK BACK PLATE EXTRA
- STEADY REST
- FOLLOW REST
- FACE PLATE
- CARRIER PLATE
- TAPER TURNING ATTACHMENT
- COOLANT PUMP WITH TANK AND FITTINGS
- REAR TOOL POST
- ELECTRICALS (MOTOR, WIRING, SWITCH, V-BELTS AND FITTINGS)
- PANEL BOARD
- SPLASH GUARD
- FOUNDATION ROUND PLATE WITH LEVELLING BOLTS
- QUICK CHANGE TOOL POST
- KEY WAY ATTACHMENT
- PADEL STOP
- ELECTRICAL THIRD SHAFT

NOTE : As improvements are constantly made in our machines, the above illustrations, specifications, dimensions and technical data are subject to modifications and change without prior notice and not binding on us.



LATHE
ISO 9001:2015
CERTIFIED COMPANY

**GEARED HEAD MEDIUM DUTY
LATHE MACHINE
MODEL - VGM-255**

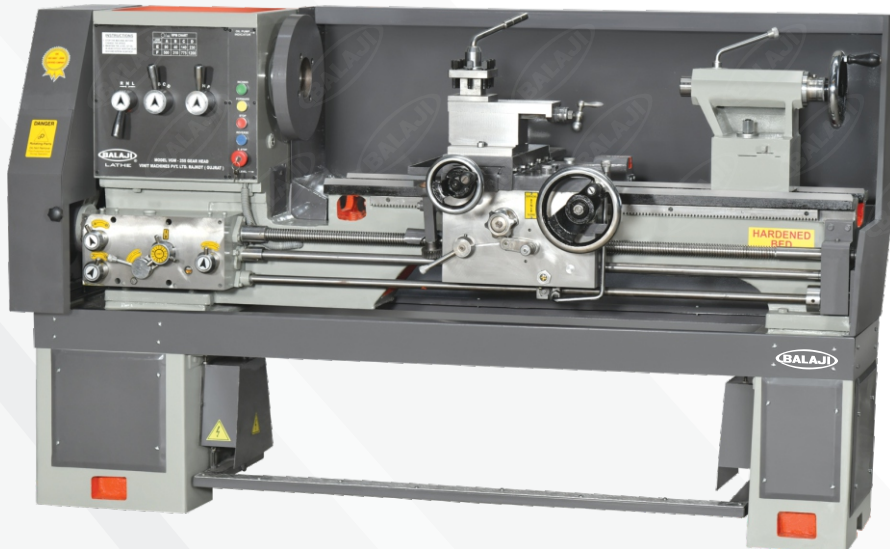



MODEL - VGM-255 GEARED HEAD MEDIUM DUTY LATHE MACHINE : TECHNICAL SPECIFICATIONS

BED	
LENGTH OF BED	1900 mm (6'-3"
ADMIT BETWEEN CENTRE	1020 mm
TYPE OF BED	Hardened Bed Ways
SWING OVER BED	495 mm
HEIGHT OF CENTRE	255 mm
WIDTH OF BED	277 mm
SWING OVER CROSS SLIDE	310 mm
SWING IN GAP	700 mm
LENGTH OF GAP IN FRONT OF FACE PLATE	150 mm

MAIN SPINDLE	
NO. OF SPINDLE SPEED	8
SPINDLE SPEED RANGE	55 to 1200 RPM*
TAPER IN SPINDLE	MT-6
SPINDLE BORE	65 mm
SPINDLE NOSE	A2-6

THREADS	
LEAD SCREW DIAMETER / PITCH	31.75 mm / 4 TPI
NOS. OF THREADS/RANGE (FOR FULL NORTON GEAR BOX)	METRIC : 24 / 0.5 mm to 15 mm PITCH INCH : 44 / 2 to 60 TPI
NO. OF FEEDS	40
RANGE OF LONGITUDINAL FEEDS	0.066 - 2 mm
RANGE OF TRANSVERSE FEEDS	0.0165 - 0.5 mm

TAIL STOCK	
TAIL STOCK SPINDLE DIAMETER	50.8 mm
TAPER IN TAIL STOCK QUILL	MT - 4

TRAVEL AND TOOLS	
CROSS SLIDE TRAVEL	270 mm
COMPOUND SLIDE TRAVEL	150 mm
TAIL STOCK SLEEVE TRAVEL	140 mm
TOOL POST SQUARE	120 mm
TOOL SHANK SIZE	25 mm
SUITABLE ELECTRICAL HP	3 HP (3 phase)

STANDARD ACCESSORIES :

- CHUCK BACK PLATE
- CENTRE ADAPTER
- DEAD CENTRES 2 NOS
- TOOL POST SPANNER
- MOTOR PULLEY
- THREAD DIAL INDICATOR
- CHANGE GEAR SET
- CHIP TRAY
- NORTON GEAR BOX WITH DOUBLE SHAFT

OPTIONAL ACCESSORIES :

- INDEPENDENT CHUCK
- SELF CENTRING CHUCK
- CHUCK BACK PLATE EXTRA
- STEADY REST
- FOLLOW REST
- FACE PLATE
- CARRIER PLATE
- TAPER TURNING ATTACHMENT
- COOLANT PUMP WITH TANK AND FITTINGS
- REAR TOOL POST
- ELECTRICALS (MOTOR, WIRING, SWITCH, V-BELTS AND FITTINGS)
- PANEL BOARD
- SPLASH GUARD
- FOUNDATION ROUND PLATE WITH LEVELLING BOLTS
- QUICK CHANGE TOOL POST
- KEYWAY ATTACHMENT
- PADEL STOP
- ELECTRICAL THIRD SHAFT

NOTE : As improvements are constantly made in our machines, the above illustrations, specifications, dimensions and technical data are subject to modifications and change without prior notice and not binding on us.



LATHE
ISO 9001:2015
CERTIFIED COMPANY

**GEARED HEAD HEAVY DUTY
LATHE MACHINE
MODEL - VGH-267**

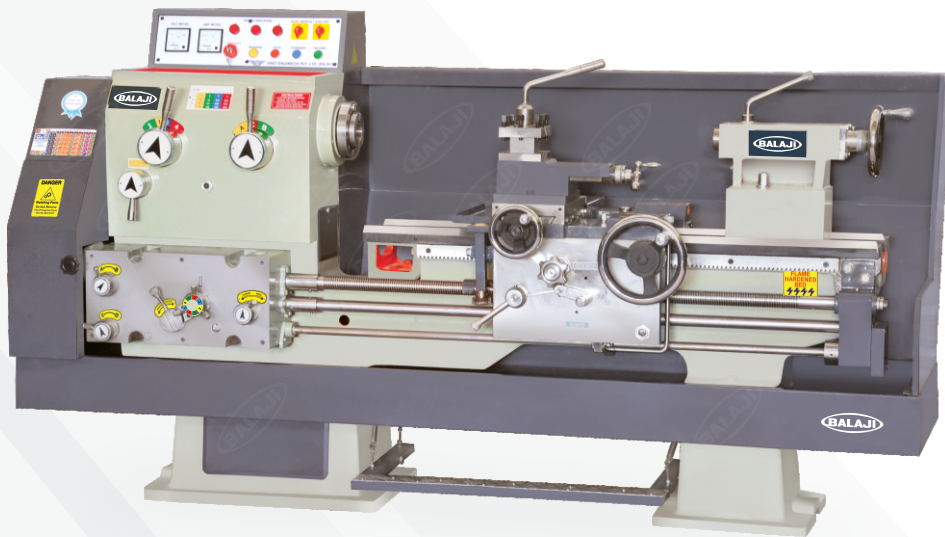



MODEL - VGH-267 GEARED HEAD HEAVY DUTY LATHE MACHINE : TECHNICAL SPECIFICATIONS

BED						
LENGTH OF BED	7' (2100 mm)	9' (2740 mm)	10' (3040 mm)	12' (3650 mm)	14' (4260 mm)	16' (4850 mm)
ADMIT BETWEEN CENTRE	1000 mm	1600 mm	1900 mm	2500 mm	3100 mm	3700 mm

TYPE OF BED	Hardened Bed Ways	
HEIGHT OF CENTRE	267 mm (10-1/2")	304 mm (12")
SWING OVER BED	525 mm	600 mm
SWING OVER CROSS SLIDE	320 mm	395 mm
SWING IN GAP	800 mm	875 mm
WIDTH OF BED	325 mm	
LENGTH OF GAP IN FRONT OF FACE PLATE	200 mm	

MAIN SPINDLE			
NO. OF SPINDLE SPEED	12		
SPINDLE SPEED RANGE	30 to 1060 RPM *		
TAPER IN SPINDLE	MT-6		
SPINDLE BORE	50 mm	79 mm	104 mm
SPINDLE NOSE	A2-6	A2-8	A2-8

THREADS	
LEAD SCREW DIAMETER / PITCH	38 mm / 4 TPI
NOS. OF THREADS/RANGE (FOR FULL NORTON GEAR BOX)	METRIC : 24 / 0.5 mm to 15 mm PITCH INCH : 44 / 2 to 60 TPI
NO. OF FEEDS	40
RANGE OF LONGITUDINAL FEEDS	0.066 - 2 mm
RANGE OF TRANSVERSE FEEDS	0.0165 - 0.5 mm

TAIL STOCK	
TAIL STOCK SPINDLE DIAMETER	60.3 mm
TAPER IN TAIL STOCK QUILL	MT - 4

TRAVEL AND TOOLS	
CROSS SLIDE TRAVEL	280 mm
COMPOUND SLIDE TRAVEL	145 mm
TAIL STOCK SLEEVE TRAVEL	170 mm
TOOL POST SQUARE	120 mm
TOOL SHANK SIZE	25 mm
SUITABLE ELECTRICAL HP	3 HP / 5 HP (3 phase)*

STANDARD ACCESSORIES :

- CHUCKBACK PLATE
- CENTRE ADAPTER
- DEAD CENTRES 2 NOS
- TOOL POST SPANNER
- MOTOR PULLEY
- THREAD DIAL INDICATOR
- CHANGE GEAR SET
- CHIP TRAY
- NORTON GEAR BOX WITH DOUBLE SHAFT

OPTIONAL ACCESSORIES :

- INDEPENDENT CHUCK
- SELF CENTRING CHUCK
- CHUCK BACK PLATE EXTRA
- STEADY REST
- FOLLOW REST
- FACE PLATE
- CARRIER PLATE
- TAPER TURNING ATTACHMENT
- COOLANT PUMP WITH TANK AND FITTINGS
- REAR TOOL POST
- ELECTRICALS (MOTOR, WIRING, SWITCH, V-BELTS AND FITTINGS)
- PANEL BOARD
- SPLASH GUARD
- FOUNDATION ROUND PLATE WITH LEVELLING BOLTS
- QUICK CHANGE TOOL POST
- KEY WAY ATTACHMENT
- PADEL STOP
- ELECTRICAL THIRD SHAFT

NOTE : As improvements are constantly made in our machines, the above illustrations, specifications, dimensions and technical data are subject to modifications and change without prior notice and not binding on us.



LATHE
ISO 9001:2015
CERTIFIED COMPANY

**GEARED HEAD HEAVY DUTY
LATHE MACHINE
MODEL - VGH-304**

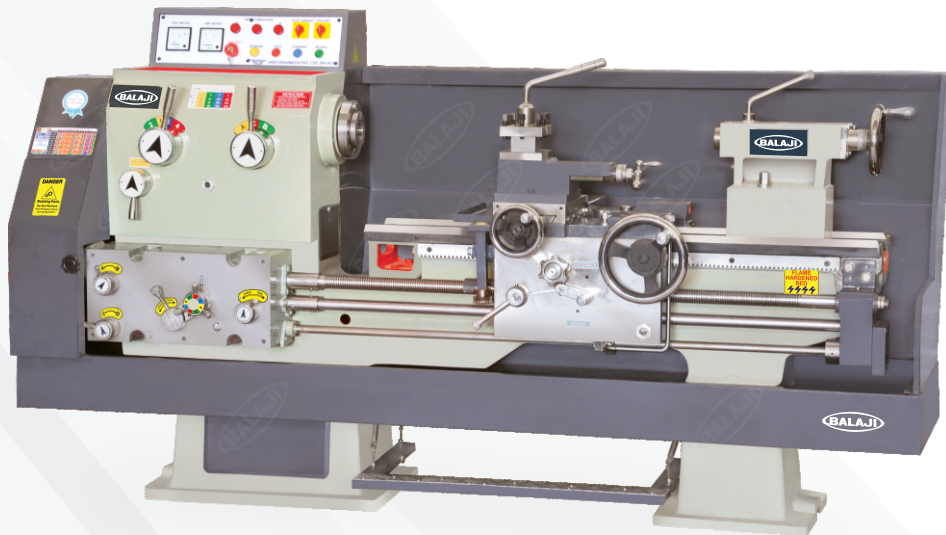



MODEL - VGH-304 GEARED HEAD HEAVY DUTY LATHE MACHINE : TECHNICAL SPECIFICATIONS

BED											
LENGTH OF BED	7' (2100 mm)	9' (2740 mm)	10' (3040 mm)	12' (3650 mm)	14' (4260 mm)	16' (4850 mm)	18' (5450 mm)	20' (6050 mm)	22' (6650 mm)	24' (7250 mm)	26' (7850 mm)
ADMIT BETWEEN CENTRE	1000 mm	1600 mm	1900 mm	2500 mm	3100 mm	3700 mm	4300 mm	4900 mm	5500 mm	6100 mm	6700 mm

TYPE OF BED	Hardened Bed Ways		
	HEIGHT OF CENTRE	304 mm (12")	355 mm (14")
SWING OVER BED	580 mm	680 mm	730 mm
SWING OVER CROSS SLIDE	390 mm	490 mm	540 mm
SWING IN GAP	890 mm	990 mm	1040 mm
WIDTH OF BED	375 mm		
LENGTH OF GAP IN FRONT OF FACE PLATE	200 mm		

MAIN SPINDLE	
NO. OF SPINDLE SPEED	12
SPINDLE SPEED RANGE	30 to 1060 RPM *
TAPER IN SPINDLE	MT-6
SPINDLE BORE	79 mm / 104 mm
SPINDLE NOSE	A2-8

THREADS	
LEAD SCREW DIAMETER / PITCH	38 mm / 4 TPI
NOS. OF THREADS/RANGE (FOR FULL NORTON GEAR BOX)	METRIC : 24 / 0.5 mm to 15 mm PITCH INCH : 44 / 2 to 60 TPI
NO. OF FEEDS	40
RANGE OF LONGITUDINAL FEEDS	0.066 - 2 mm
RANGE OF TRANSVERSE FEEDS	0.0165 - 0.5 mm

TAIL STOCK	
TAIL STOCK SPINDLE DIAMETER	60.3 mm
TAPER IN TAIL STOCK QUILL	MT - 4

TRAVEL AND TOOLS	
CROSS SLIDE TRAVEL	325 mm
COMPOUND SLIDE TRAVEL	190 mm
TAIL STOCK SLEEVE TRAVEL	170 mm
TOOL POST SQUARE	145 mm
TOOL SHANK SIZE	25 mm
SUITABLE ELECTRICAL HP	5 HP (3 phase)*

STANDARD ACCESSORIES :

- CHUCK BACK PLATE
- CENTRE ADAPTER
- DEAD CENTRES 2 NOS
- TOOL POST SPANNER
- MOTOR PULLEY
- THREAD DIAL INDICATOR
- CHANGE GEAR SET
- CHIP TRAY
- NORTON GEAR BOX WITH DOUBLE SHAFT

OPTIONAL ACCESSORIES :

- INDEPENDENT CHUCK
- SELF CENTRING CHUCK
- CHUCK BACK PLATE EXTRA
- STEADY REST
- FOLLOW REST
- FACE PLATE
- CARRIER PLATE
- TAPER TURNING ATTACHMENT
- COOLANT PUMP WITH TANK AND FITTINGS
- REAR TOOL POST
- ELECTRICALS (MOTOR, WIRING, SWITCH, V-BELTS AND FITTINGS)
- PANEL BOARD
- SPLASH GUARD
- FOUNDATION ROUND PLATE WITH LEVELLING BOLTS
- QUICK CHANGE TOOL POST
- KEY WAY ATTACHMENT
- PADEL STOP
- ELECTRICAL THIRD SHAFT

NOTE : As improvements are constantly made in our machines, the above illustrations, specifications, dimensions and technical data are subject to modifications and change without prior notice and not binding on us.



LATHE

ISO 9001:2015
CERTIFIED COMPANY

**GEARED HEAD
EXTRA HEAVY DUTY LATHE MACHINE
VGH-406**

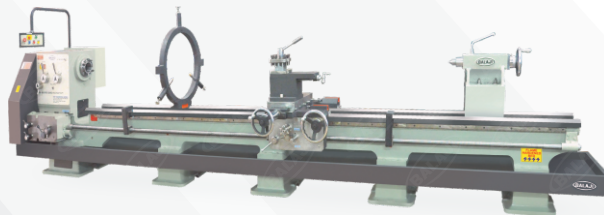



MODEL - VGH-406 GEARED HEAD EXTRA HEAVY DUTY LATHE MACHINE : TECHNICAL SPECIFICATIONS

BED											
LENGTH OF BED	7' (2100 mm)	9' (2740 mm)	10' (3040 mm)	12' (3650 mm)	14' (4260 mm)	16' (4850 mm)	18' (5450 mm)	20' (6050 mm)	22' (6650 mm)	24' (7250 mm)	26' (7850 mm)
ADMIT BETWEEN CENTRE	700 mm	1300 mm	1600 mm	2200 mm	2800 mm	3400 mm	4000 mm	4600 mm	5200 mm	5800 mm	6400 mm

TYPE OF BED	Hardened Bed Ways	
	HEIGHT OF CENTRE	406 mm (16")
SWING OVER BED	785 mm	885 mm
SWING OVER CROSS SLIDE	480 mm	580 mm
SWING IN GAP	1100 mm	1200 mm
WIDTH OF BED	455 mm	
LENGTH OF GAP IN FRONT OF FACE PLATE	250 mm*	

MAIN SPINDLE	
NO. OF SPINDLE SPEED	9
SPINDLE SPEED RANGE	19 to 310 RPM*
TAPER IN SPINDLE	MT-6
SPINDLE BORE	100 mm
SPINDLE NOSE	A2-8

THREADS	
LEAD SCREW DIAMETER / PITCH	44.4 mm / 2 TPI
NOS. OF THREADS/RANGE (FOR FULL NORTON GEAR BOX)	METRIC : 24 / 0.5 mm to 15 mm PITCH INCH : 44 / 2 to 60 TPI
NO. OF FEEDS	40
RANGE OF LONGITUDINAL FEEDS	0.066 - 2 mm
RANGE OF TRANSVERSE FEEDS	0.0165 - 0.5 mm

TAIL STOCK	
TAIL STOCK SPINDLE DIAMETER	76 mm
TAPER IN TAIL STOCK QUILL	MT - 5

TRAVEL AND TOOLS	
CROSS SLIDE TRAVEL	500 mm*
COMPOUND SLIDE TRAVEL	250 mm
TAIL STOCK SLEEVE TRAVEL	250 mm
TOOL POST SQUARE	175 mm
TOOL SHANK SIZE	38 mm
SUITABLE ELECTRICAL HP	7.5 HP (3 phase) (960 RPM)

STANDARD ACCESSORIES :

- CHUCK BACK PLATE
- CENTRE ADAPTER
- DEAD CENTRES 2 NOS
- TOOL POST SPANNER
- MOTOR PULLEY
- THREAD DIAL INDICATOR
- CHANGE GEAR SET
- CHIP TRAY
- NORTON GEAR BOX WITH DOUBLE SHAFT

OPTIONAL ACCESSORIES :

- INDEPENDENT CHUCK
- SELF CENTRING CHUCK
- CHUCK BACK PLATE EXTRA
- STEADY REST
- FOLLOW REST
- FACE PLATE
- CARRIER PLATE
- TAPER TURNING ATTACHMENT
- COOLANT PUMP WITH TANK AND FITTINGS
- ELECTRICALS (MOTOR, WIRING, SWITCH, V-BELTS AND FITTINGS)
- PANEL BOARD
- SPLASH GUARD
- FOUNDATION ROUND PLATE WITH LEVELLING BOLTS
- QUICK CHANGE TOOL POST
- KEYWAY ATTACHMENT
- PADEL STOP
- ELECTRICAL THIRD SHAFT

NOTE : As improvements are constantly made in our machines, the above illustrations, specifications, dimensions and technical data are subject to modifications and change without prior notice and not binding on us.



LATHE
ISO 9001:2015
CERTIFIED COMPANY

**GEARED HEAD
EXTRA HEAVY DUTY LATHE MACHINE
VGH-508**

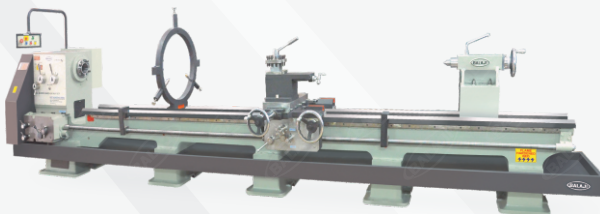

**GEARED HEAD
EXTRA HEAVY DUTY LATHE MACHINE**



MODEL - VGH-508 GEARED HEAD EXTRA HEAVY DUTY LATHE MACHINE : TECHNICAL SPECIFICATIONS

BED											
LENGTH OF BED	7' (2100 mm)	9' (2740 mm)	10' (3040 mm)	12' (3650 mm)	14' (4260 mm)	16' (4850 mm)	18' (5450 mm)	20' (6050 mm)	22' (6650 mm)	24' (7250 mm)	26' (7850 mm)
ADMIT BETWEEN CENTRE	700 mm	1300 mm	1600 mm	2200 mm	2800 mm	3400 mm	4000 mm	4600 mm	5200 mm	5800 mm	6400 mm

TYPE OF BED	Hardened Bed Ways
HEIGHT OF CENTRE	508 mm (20")
SWING OVER BED	985 mm
SWING OVER CROSS SLIDE	680 mm
SWING IN GAP	1300 mm
WIDTH OF BED	558 mm
LENGTH OF GAP IN FRONT OF FACE PLATE	250 mm*

MAIN SPINDLE	
NO. OF SPINDLE SPEED	9
SPINDLE SPEED RANGE	19 to 310 RPM*
TAPER IN SPINDLE	MT-6
SPINDLE BORE	100 mm
SPINDLE NOSE	A2-8

THREADS	
LEAD SCREW DIAMETER / PITCH	44.4 mm / 2 TPI
NOS. OF THREADS/RANGE (FOR FULL NORTON GEAR BOX)	METRIC : 24/0.5 mm to 15 mm PITCH INCH : 44 / 2 to 60 TPI
NO. OF FEEDS	40
RANGE OF LONGITUDINAL FEEDS	0.066 - 2 mm
RANGE OF TRANSVERSE FEEDS	0.0165 - 0.5 mm

TAIL STOCK	
TAIL STOCK SPINDLE DIAMETER	76 mm
TAPER IN TAIL STOCK QUILL	MT - 5

TRAVEL AND TOOLS	
CROSS SLIDE TRAVEL	550 mm*
COMPOUND SLIDE TRAVEL	250 mm
TAIL STOCK SLEEVE TRAVEL	250 mm
TOOL POST SQUARE	175 mm
TOOL SHANK SIZE	38 mm
SUITABLE ELECTRICAL HP	7.5 HP (3 phase) (960 RPM)

STANDARD ACCESSORIES :

- CHUCK BACK PLATE
- CENTRE ADAPTER
- DEAD CENTRES 2 NOS
- TOOL POST SPANNER
- MOTOR PULLEY
- THREAD DIAL INDICATOR
- CHANGE GEAR SET
- CHIP TRAY
- NORTON GEAR BOX WITH DOUBLE SHAFT

OPTIONAL ACCESSORIES :

- INDEPENDENT CHUCK
- SELF CENTRING CHUCK
- CHUCK BACK PLATE EXTRA
- STEADY REST
- FOLLOW REST
- FACE PLATE
- CARRIER PLATE
- TAPER TURNING ATTACHMENT
- COOLANT PUMP WITH TANK AND FITTINGS
- ELECTRICALS (MOTOR, WIRING, SWITCH, V-BELTS AND FITTINGS)
- PANEL BOARD
- SPLASH GUARD
- FOUNDATION ROUND PLATE WITH LEVELLING BOLTS
- QUICK CHANGE TOOL POST
- KEY WAY ATTACHMENT
- PADEL STOP
- ELECTRICAL THIRD SHAFT

NOTE : As improvements are constantly made in our machines, the above illustrations, specifications, dimensions and technical data are subject to modifications and change without prior notice and not binding on us.



LATHE
ISO 9001:2015
CERTIFIED COMPANY

**GEARED HEAD
EXTRA HEAVY DUTY LATHE MACHINE
VGH-558**





MODEL - VGH-558 GEARED HEAD EXTRA HEAVY DUTY LATHE MACHINE : TECHNICAL SPECIFICATIONS

BED										
LENGTH OF BED	10' (3040 mm)	12' (3650 mm)	14' (4260 mm)	16' (4850 mm)	18' (5450 mm)	20' (6050 mm)	22' (6650 mm)	24' (7250 mm)	26' (7850 mm)	
ADMIT BETWEEN CENTRE	1200 mm	1800 mm	2400 mm	3000 mm	3600 mm	4200 mm	4800 mm	5400 mm	6000 mm	

TYPE OF BED	Hardened Bed Ways	
HEIGHT OF CENTRE	558 mm (22")	609 (24")
SWING OVER BED	1075 mm	1175 mm
SWING OVER CROSS SLIDE	750 mm	850 mm
SWING IN GAP	1400 mm	1500 mm
WIDTH OF BED	660 mm	
LENGTH OF GAP IN FRONT OF FACE PLATE	250 mm*	

MAIN SPINDLE	
NO. OF SPINDLE SPEED	8
SPINDLE SPEED RANGE	14 to 200 RPM*
TAPER IN SPINDLE	MT-6
SPINDLE BORE	115 mm
SPINDLE NOSE	A2-11

THREADS	
LEAD SCREW DIAMETER / PITCH	44.4 mm / 2 TPI
NOS. OF THREADS/RANGE (FOR FULL NORTON GEAR BOX)	METRIC : 24/0.5 mm to 15 mm PITCH INCH : 44 / 2 to 60 TPI
NO. OF FEEDS	40
RANGE OF LONGITUDINAL FEEDS	0.066 - 2 mm
RANGE OF TRANSVERSE FEEDS	0.0165 - 0.5 mm

TAIL STOCK	
TAIL STOCK SPINDLE DIAMETER	100 mm
TAPER IN TAIL STOCK QUILL	MT - 5

TRAVEL AND TOOLS	
CROSS SLIDE TRAVEL	550 mm*
COMPOUND SLIDE TRAVEL	250 mm
TAIL STOCK SLEEVE TRAVEL	250 mm
TOOL POST SQUARE	200 mm
TOOL SHANK SIZE	38 mm
SUITABLE ELECTRICAL HP	15 HP (3 phase) (960 RPM)

STANDARD ACCESSORIES :

- CHUCK BACK PLATE
- CENTRE ADAPTER
- DEAD CENTRES 2 NOS
- TOOL POST SPANNER
- MOTOR PULLEY
- THREAD DIAL INDICATOR
- CHANGE GEAR SET
- CHIP TRAY
- NORTON GEAR BOX WITH DOUBLE SHAFT

OPTIONAL ACCESSORIES :

- INDEPENDENT CHUCK
- SELF CENTRING CHUCK
- CHUCK BACK PLATE EXTRA
- STEADY REST
- FOLLOW REST
- FACE PLATE
- CARRIER PLATE
- TAPER TURNING ATTACHMENT
- COOLANT PUMP WITH TANK AND FITTINGS
- ELECTRICALS (MOTOR, WIRING, SWITCH, V-BELTS AND FITTINGS)
- PANEL BOARD
- SPLASH GUARD
- FOUNDATION ROUND PLATE WITH LEVELLING BOLTS
- QUICK CHANGE TOOL POST
- KEY WAY ATTACHMENT
- PADEL STOP
- ELECTRICAL THIRD SHAFT

NOTE : As improvements are constantly made in our machines, the above illustrations, specifications, dimensions and technical data are subject to modifications and change without prior notice and not binding on us.



BALAJI
LATHE

SABARI
LATHE

VINIT
LATHE

VINIT MACHINES PVT. LTD.

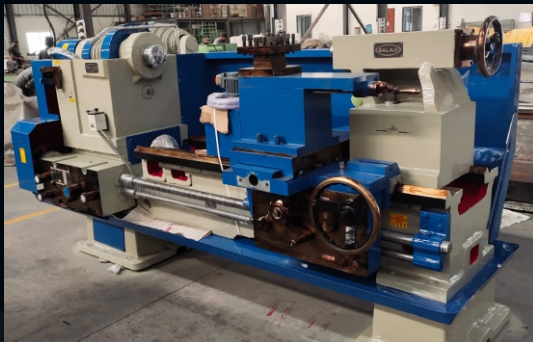

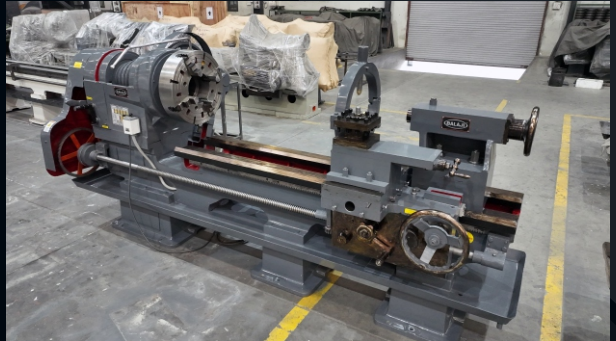

inside Story

Capability to provide custom lathe machines as per client's requirements in cost-effective, quality centric and time bound frame.



VINIT MACHINES PVT.LTD.





VINIT MACHINES PVT. LTD.

Balaji Industrial Zone - A, Plot No. 44, Ribda Ardoi Road, Off National Highway, Ribda, Rajkot - 360 311. India.

Cell : +91 94273 96228  WhatsApp : +91 94273 96228 ● E-mail : vinit@balajilathe.com
Cell : +91 72260 41935  WhatsApp : +91 72260 41935 ● Web : www.balajilathe.com